

THE WAVES WERE BEATING THE HELL OUT OF THE BOAT.

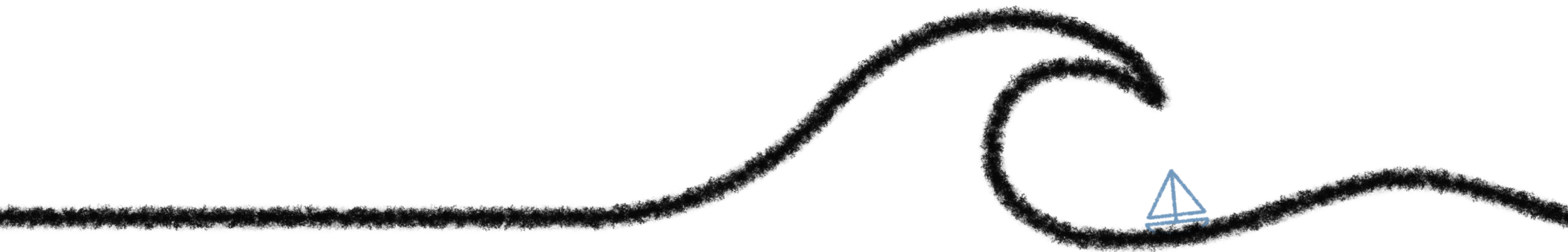

BENJAMIN D'AMICO

...

A DESIGN PORTFOLIO

As I ROCKED BACK AND FORTH ON DECK,  
I TOOK NOTE OF MY CURRENT STATE OF AFFAIRS.

I was 25, broke, and still drifting aimlessly...

...this time out into the middle of Tampa Bay  
aboard the 26-foot sailboat that an acquaintance  
from Craigslist had just given to me  
– *for free.*

Yet, as inspiring as it was to be given a boat by a complete stranger,

SOMETHING DIDN'T FEEL RIGHT.



The words,  
“**WHAT DO I REALLY WANT FROM LIFE,**”  
echoed in my head with each stormy wave,

and so I drifted off into  
memories of the life that had led me to this point.

*I thought back to the adventure that I had just returned home from:*

The **ROAD TRIP** that was **SUPPOSED**  
to provide me with **ALL** of the **ANSWERS...**

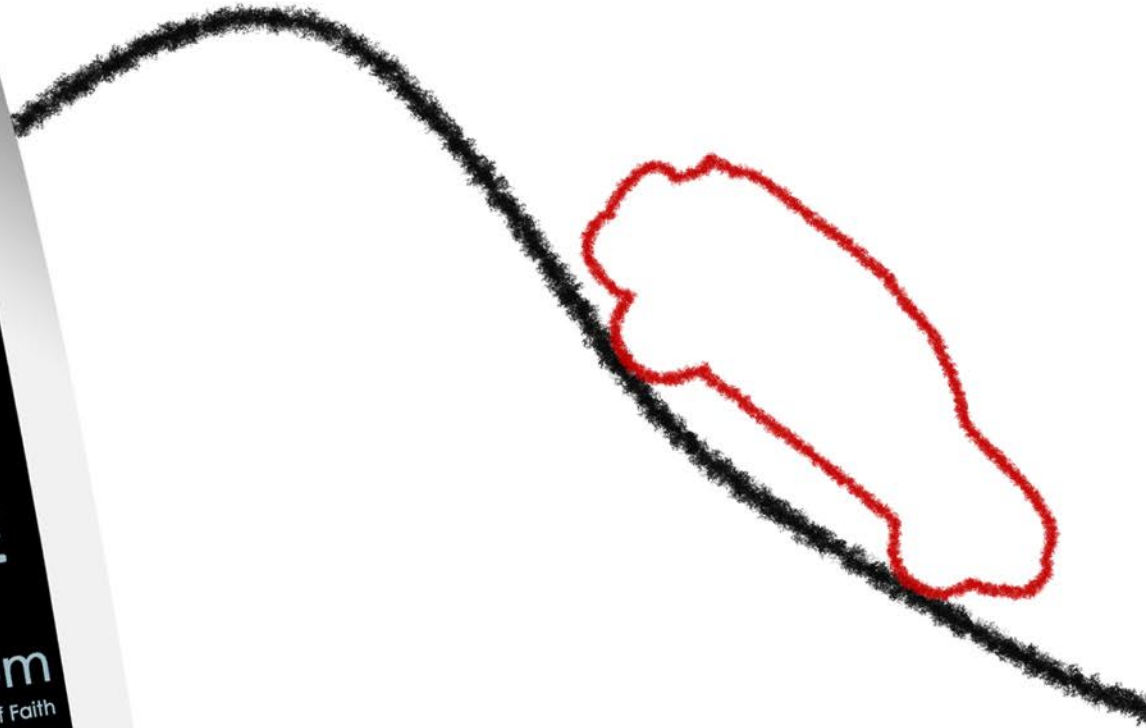
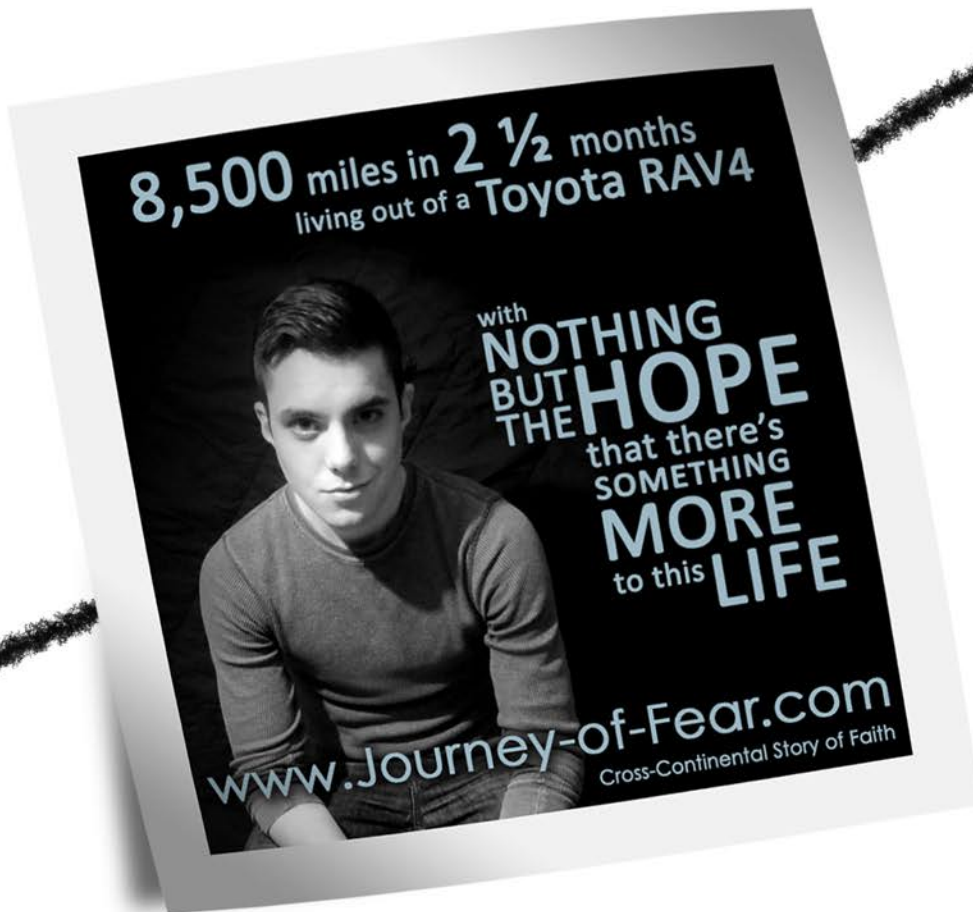

BUT INSTEAD LEFT ME WITH JUST  
AS MANY QUESTIONS AS BEFORE



I REMEMBERED THE WEEKS BEFORE THAT ROAD TRIP,  
when I transformed the RAV4 into a micro-camper.

---

and I remembered thinking to myself,

***"HOW AM I GOING TO GET A SHOWER IN HERE?"***

Because running water was the ONE thing  
that I refused to give up.

**I EVENTUALLY DID FIGURE IT OUT.**



Then my mind wandered back to the disheartening events which had led to my desire to escape on that road trip:



Like the Freelance Copywriting Career that I *unsuccessfully* attempted to launch,

## EVEN AFTER:

- Designing, Printing, and Mailing out dozens of promotional self-mailers and coupons 
- Cold-calling 120 web-design firms around the Greater Pittsburgh area



*Bendamico.com*

...and teaching myself HTML, CSS, and (some) jQuery  
in order to create a website that I could proudly share with customers.



• MENU •

• LET'S TALK!



Benjamin D. D'Amico

Marketing & Web Copywriter

Words Inspire Action

Then there was the LED lighting company that I *failed* to launch.



It started with the idea of creating customizable accent light fixtures that functioned as decorative trim, which could be installed in various configurations to create a multitude of visual effects...



and could also be stained/treated to suit the existing decor of any bar, restaurant, or store showcase.

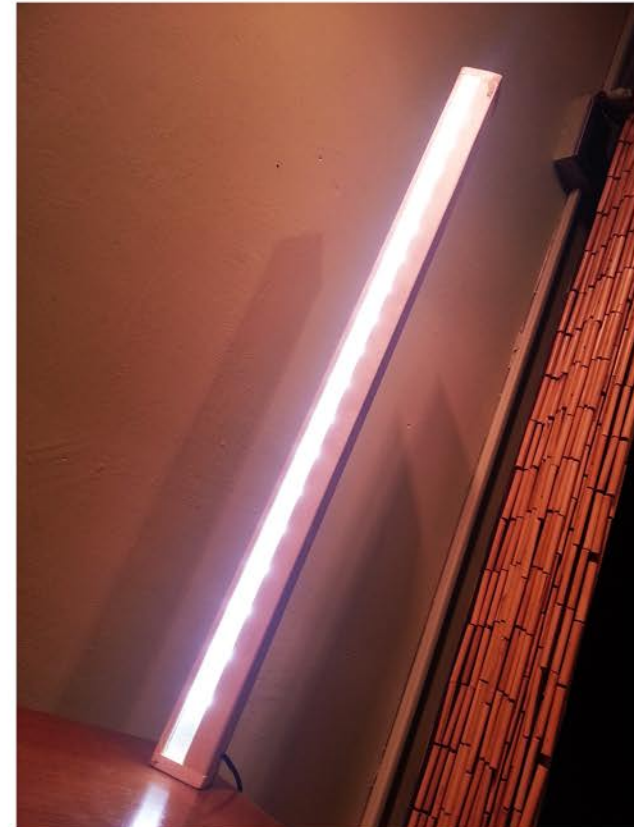

The idea eventually transformed into a consumer-oriented lighting company –



That is, until I finally realized that running a manufacturing operation out my parents' shed with a single extension cord – and no money – was hardly feasible.

And then there was that...OTHER business idea,  
which surprisingly never took off



*The Affectionate*  
**JACKASS**  
PRANK GREETING CARD COMPANY

The online business that would allow users to create *personalized prank greeting cards*, which we would then print and ship to their "friend's" door.

S.O.M.P.  
PO Box 578243  
Irwin, PA 15642

Danny Dila  
7243 Familia Drive  
Marlborough, NJ 08755

VOID  
NO POSTAGE  
NECESSARY  
IF MAILED  
IN THE  
UNITED STATES

### SEX OFFENDER NOTICE



**Name:** Danny Dila  
**Age:** 26  
**Sex:** Male  
**Race:** Caucasian  
**Height:** 6'4"  
**Weight:** 195 lbs  
**Hair:** Brown  
**Eyes:** Hazel

**Comments:**  
In 2011, Offender was convicted of Patronizing a Prostitute in the Second Degree. On 4/13/2013, Offender was convicted of Incest in the Second Degree.

**7243 Familia Drive**  
Appalachian Dirty Darts Sister Slayes  
Lowes Back tattoos  
11/07/11 01/08/12  
08/13/13 05/03/13

### How To Use This Information

Should you find yourself able to recognize the individual depicted in the above profile, we would first like to remind you that sex offenders are still people, and deserve as much respect as anyone else. We do, however, urge you to remain vigilant, noting any unusual activities that the above individual may exhibit. We advise making your observance perceptible to the offender, which can be done by placing community watch stickers/emblems on the outside of your residence or by simply making your presence known when young children are outside. This will help dissuade against any future offenses. Should you bear witness to any actions that are out of the ordinary by the above offender, then we urge you to contact the Sex Offender Monitor Program immediately. Our ability to keep our neighborhoods safe relies on being able to track and monitor the activities of all sex offenders within our database, and we need your help. To document suspicious activities, or for more information about our organization, contact Jack Aspinwall at - yeah, that's right. This notice is a fake, set up by your friend Jack Aspinwall. You know what is real? The friendship and care that you and Jack share. Courtesy of the Affectionate Jackass, they set up this prank greeting card, simply to say: "Hey little buddy, just wanted to wish you and Christine congrats on the new baby - in my own special way!" But seriously Danny you'd better watch your step - because the neighbors will be watching.

• The Sex Offender Monitor Program is a charitable group not associate with law enforcement •



Dear Recipient,

Keeping our nation's streets safe from the dangers of past sexual offenders is vital when cultivating healthy, thriving communities.

We're pleased to introduce to you the Sex Offender Monitor Program. SOMP is a newly formed charitable organization that aims to keep parents and community members well informed as to the activities of registered sex offenders living in your vicinity.

We will be sending you and your neighbors monthly updates, similar to this one, detailing the whereabouts of individuals who are currently listen within SOMP's high-priority watch list.

Together with the Sex Offender Monitor Program we can build healthier, happier communities across America - keeping our children safe. To make a donation, see our contact details inside.

Sincerely,

Paul Castitudo  
Executive Director

## SEX OFFENDER NOTICE



**Age:** \_\_\_\_\_ **Name:** \_\_\_\_\_  
**Sex:** \_\_\_\_\_  
**Race:** \_\_\_\_\_  
**Height:** \_\_\_\_\_  
**Weight:** \_\_\_\_\_  
**Hair:** \_\_\_\_\_  
**Eyes:** \_\_\_\_\_

**Comments:**  
In 2011, Offender was convicted of Patronizing a Prostitute in the Second Degree. On 4/13/2013, Offender was convicted of Incest in the Second Degree.

**STREET ADDRESS:** \_\_\_\_\_ **CITY:** \_\_\_\_\_ **COUNTY:** \_\_\_\_\_ **STATE:** \_\_\_\_\_ **ZIP:** \_\_\_\_\_

**ALIAS:** \_\_\_\_\_

**LOCATION:** \_\_\_\_\_ **TYPE/DESCRIPTION:** \_\_\_\_\_ **SCARS/TATTOOS:** \_\_\_\_\_

DATE COMMITTED	DATE CONVICTED	COUNTS	DESCRIPTION	OFFENSE	CRIME DETAILS
11/07/11	01/08/12	1	621 (g) (2)	- PATRON. PROSTITUTE	LEVEL 1
04/13/13	05/03/13	2	10-7065	- INCEST 2ND DEGREE	

### How To Use This Information

Should you find yourself able to recognize the individual depicted in the above profile, we would first like to remind you that sex offenders are still people, and deserve as much respect as anyone else.

We do, however, urge you to remain vigilant, noting any unusual activities that the above individual may exhibit. We advise making your observance perceptible to the offender, which can be done by placing community watch stickers/emblems on the outside of your residence or by simply making your presence known when young children are outside. This will help dissuade against any future offenses. Should you bear witness to any actions that are out of the ordinary by the above offender, then we urge you to contact the Sex Offender Monitor Program immediately. Our ability to keep our neighborhoods safe relies on our ability to track and monitor the activities of all sex offenders within our database, and we need your help. To document suspicious activities, or for more information about our organization, contact [Sender's Full Name] at - yeah, that's right, your friend [Sender] set this up. This notice isn't real. But you know what is? The friendship and care that you and [Sender] share. Courtesy of The Affectionate Jackass, he set up this prank greeting card, simply to say: "[Personalized message - up to 175 characters]" But seriously [Recipient], you'd better watch your step - because the neighbors will be watching.

• The Sex Offender Monitor Program is a charitable group not associate with law enforcement •

Like a card that makes your buddy think that he's been placed on his community's sex offender watch list!

Dear [recipient full name],

Hi! How are you? My name's Skiff. I'm [father]'s brother. So I'm your uncle! Librarian helped me get your address on one of them online computers.

Your grampa had me before you're dad with my mom Candy. She said I was the apple in his eye. I only met him once. Dad said that your gramma didn't like me or want to meet me and to not call their house.

Do you like living in [city]? I heard its nice up there. Are you married? I'm married. Her name is angel. I think it would be neat to meet you!

Angel thinks it would be neat too. Then you could meat Tank (dog) and the kids . There are three of them.

Our house got ruined in a mud slide. It ripped it off the sinder blocks and took it down the hill. The chevy was ayok tho! We have been living in georgia for the past six years.

Shop n save got mad at us for staying in the parking lot. The home less shelter had this type wrighter. They say we have too leave to.

We thought we might head up your way and stay fore a little while-just until we get on our feet. Angle is with someone else, but I'm gonna make her come to. Tell your dad that i said hi and it will be good to meet him (I couldn't find his adress.)

The kids can sleep on the floor. Angel is reel easy company-she likes being out doors anyway. Tank is not. Do you like dogs? Do you have a basement with a lock? Cannot wait to see you!

From.

Uncle Skiff

P-S: We don't have a phone right now. (tank ate agel's) We can talk when we get there in a cople of days.

PP-S: Do you have shampoo and budweiser? Kids told me to ask.

TANKS FAULT ->

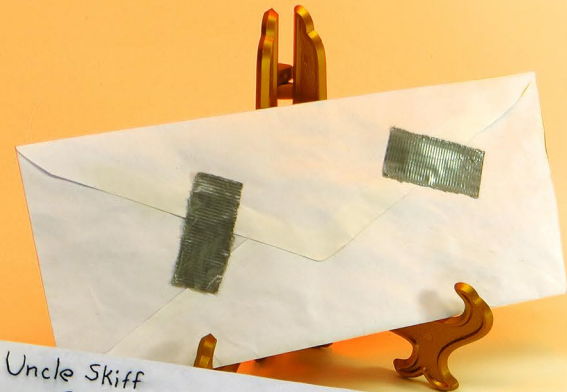

Uncle Skiff  
?

Frank Dames  
176 Richmond Dr  
New York, New York 10004

Dear [recipient first name],

It's me, uncle skiff again! How are you? We are on the road and heading your way. Things are taking longer than we thought, so we're gonna be a little late.

I just wanted you to know that we got a new cat! His name is shredder. He'll be coming with us. He only has one eye. Try not to look at it.

Also, I hope you don't mind that we decided to bring Sue and her boyfriend (Sue is my sister) with us. She got kickd out of rehab.

Sincerely...

Ok, time to cut the crap.

Uncle Skiff isn't real. But you know who is? [sender full name] Yup, your pal [sender first name] set all this up!

You see, [sender] cares about you! And rather than simply telling you that or giving you some crap card, [he/she] decided to terrify you with this whole Uncle Skiff ruse first--and THEN tell you:

[personalized message -- up to 175 characters]

By the way, we're sorry to disappoint...to be honest, Uncle Skiff did sound like a lot of fun -- as did Angel, Sue, Shredder and Tank. At least we would've had fun. Way to be judgmental, [recipient].

Sincerely,

- Your friends at The Affectionate Jackass

Or a mysteriously disgusting, two-part letter that bodes of an impending visit from a distant, uncultivated family relation  
...UNCLE SKIFF



And this little gem particularly useful for newlyweds and friends who live with their mother

Of course, as I'd eventually learn...  
even when printing your own greeting cards,  
*you still need money to market them.*

AND THUS,  
THE AFFECTIONATE JACKASS  
SANK AS WELL.

A PARTICULARLY LARGE WAVE STRUCK THE SIDE OF THE BOAT,  
SPLASHING ME IN THE FACE.

Fortunately, it jogged me from my  
growing list of "failures."

BECAUSE IF THERE WAS ONE THING THAT I'D LEARNED FROM MY LITTLE ROAD TRIP IN THE RAV4,  
IT WAS THAT **THE KEY TO A JOYFUL LIFE  
LIES IN A POSITIVE MIND.**



# SO I THOUGHT BACK TO A HAPPIER TIME — MY SENIOR YEAR IN COLLEGE



I had a fantastic job as a lighting technician/programmer and audio engineer in several Columbus churches and nightclubs.

At that same time, I took an independent study, in which I was prompted to write a comprehensive business plan for my own company.

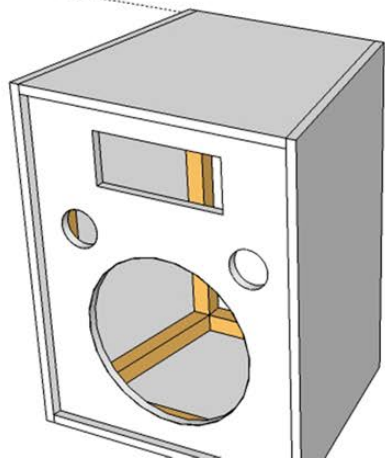

And I decided to write one for a sound system design/manufacturing company, because I'd tried my hand at speaker design in the past, and *loved* the process.

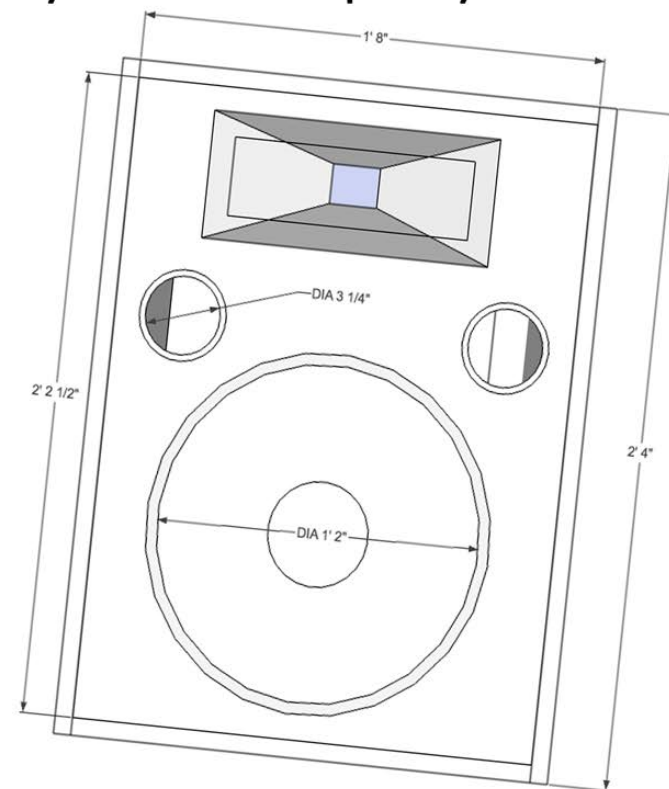

At that point, I knew that *no sound system manufacturers were specifically catering to the wants/needs of college students.*

**So I set out to uncover what College-Aged Generation Y-ers wanted from their sound systems.**

My first survey, which I hosted online, taught me two things:

No two college students want the exact same sound system – while one might prefer bluetooth capability, another might only ever use an iPod dock

The way marketers currently sell sound systems – *with a one-size/color/function-fits-all approach* – needed to go. Especially when selling to college students.

So my next survey, which I convinced 80+ students to participate in (*via candy bars*), was designed to test out some of the product ideas that I'd begun tossing around.

Gender:  
 Male  
 Female

Are you currently/did you at one time pursue any type of music technology degree program while in college?  
 Yes  No  Did not attend college

On average, how many nights per month do you host events in your place of residence for which you require a home sound system for entertainment?  
 0  1  2  3+

What level of importance do you place on having a quality home sound system in your place of residence?  
 High  Average  Low

What is the MAXIMUM amount that you would be willing to spend on your ideal home sound system?  
 ≤\$125  \$150-\$225  \$275+

Would you rather have a high volume/high bass party sound system, or a normal volume/bass living room sound system?  
 High Volume  Normal Volume

What is your current university status?  
 1<sup>st</sup> Year  2<sup>nd</sup> Year  3<sup>rd</sup> Year  4<sup>th</sup> Year  N/A

Directly below is a home sound system, which we will call Product A. Beneath Product A is a series of alternate products that are completely identical to it, save for the described differences. For each alternate product, please compare it to Product A and fill in the check mark that best describes how YOU feel that the two compare in value. **Value is NOT how much you feel that the product should cost**, but rather how appealing it is to your own personal tastes and preferences, and how compelled you would be to purchase that product. Then, inside each green box with a dollar sign, please tell us how much more you feel that each alternate product is worth than product A (i.e. if system A costs x amount, how much more should each alternate cost).

**Product A:**  
 Only Comes in one color: black • 2 speakers, one subwoofer, one volume control • 300 total watts • Several different input types



**Product B:**  
 Buyer is given the option to choose from different color choices: i.e. red, blue, green, purple, yellow, orange, etc.



In my PERSONAL OPINION, this product has \_\_\_\_\_ Product A.

about the same value as  a little bit more value than  much more value than  even less value than

**Product C:**  
 Buyer is able to choose to have a personalized graphic/logo placed on the side of the speakers



In my PERSONAL OPINION, this product has \_\_\_\_\_ Product A.

about the same value as  a little bit more value than  much more value than  even less value than

**Product D:**  
 Entire system's color can be personalized, including both the cabinets and the speakers themselves



In my PERSONAL OPINION, this product has \_\_\_\_\_ Product A.

about the same value as  a little bit more value than  much more value than  even less value than

**Product E:**  
 The speakers and subwoofer are wireless, unlike Product A



In my PERSONAL OPINION, this product has \_\_\_\_\_ Product A.

about the same value as  a little bit more value than  much more value than  even less value than

**Product F:**  
 This product has glowing LED lights built in, which can be set to pulse to the beat of the music. Buyer chooses which color they want the LEDs to be upon ordering.



In my PERSONAL OPINION, this product has \_\_\_\_\_ Product A.

about the same value as  a little bit more value than  much more value than  even less value than

**Product G:**  
 Unlike Product A which has multiple inputs and features, Product G only has one or two basic ones. Instead, Product G gives the buyer the option to purchase easy-to-install expansion modules. This makes the initial base product cheaper than product A, and also allows the buyer to only pay for which inputs/features that he or she truly needs. Examples of possible modules include wireless connection, Bluetooth, an iPod Dock, a CD Player, etc.

In my PERSONAL OPINION, this product has \_\_\_\_\_ Product A.

about the same value as  a little bit more value than  much more value than  even less value than

When you are buying a sound system, is it important to you to have surround sound?  
 Yes  No

I LEARNED THAT STUDENTS LIKE COLOR. THEY LIKE LOUD – BOTH VISUALLY AND AUDIBLY.

And more importantly,  
*they like having a way to express themselves  
through the products that they buy.*

SO I DESIGNED A SOUND SYSTEM  
TO REFLECT JUST THAT:

---

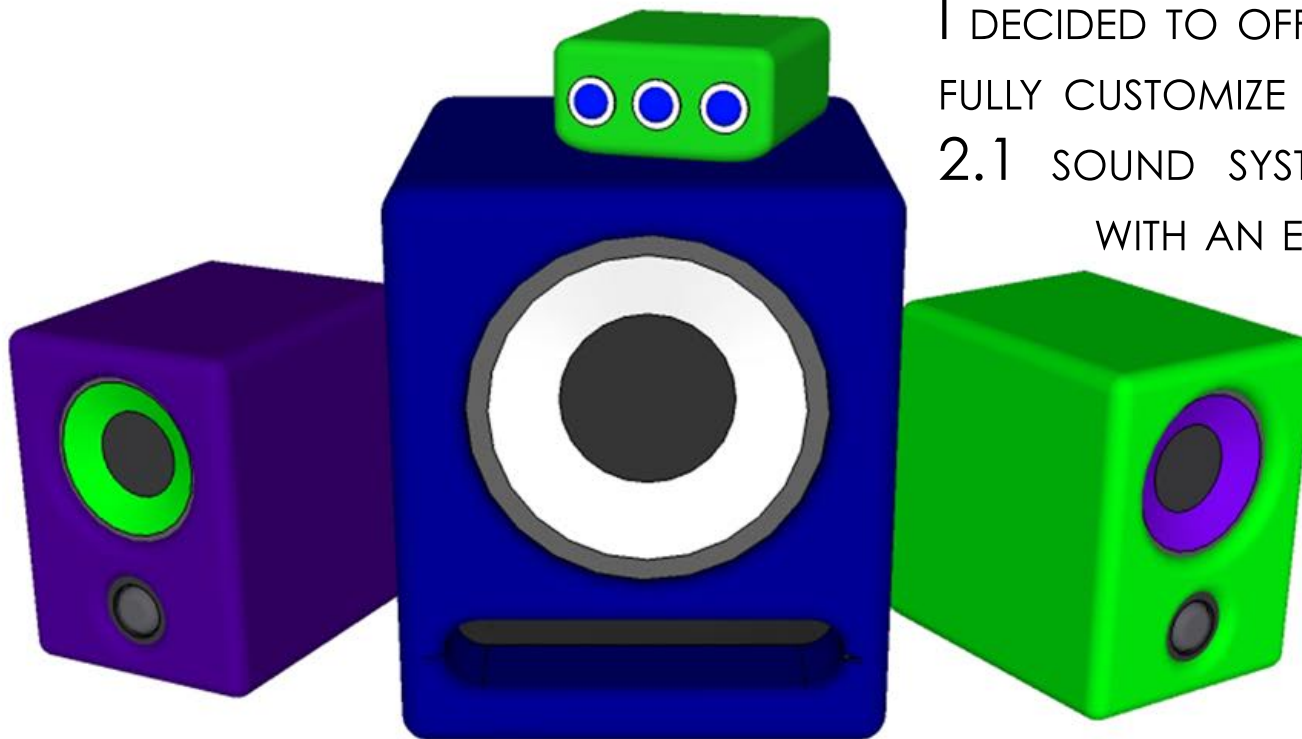

I DECIDED TO OFFER CUSTOMERS THE ABILITY TO FULLY CUSTOMIZE THE COLOR SCHEME OF THEIR 2.1 SOUND SYSTEMS THROUGH THE WEBSITE, WITH AN ENTIRELY DIRECT-TO-CONSUMER ONLINE BUSINESS MODEL.

THE BASE PRODUCT WOULD INCLUDE TWO “BOOKSHELF SPEAKERS,” A SUBWOOFER, AND A SMALL, 3-KNOB CONTROL SYSTEM,

*WITH A PARTICULARLY UNIQUE FUNCTION...*

The only audio input included in the base purchase would be an 1/8<sup>th</sup> inch auxiliary input wire – for MP3 players or computers.

But consumers would have the option to purchase **add-on input modules**, to suit their particular needs. The modules would stack on top of and lock into the control unit, and would connect via specially designed plugs in the back.

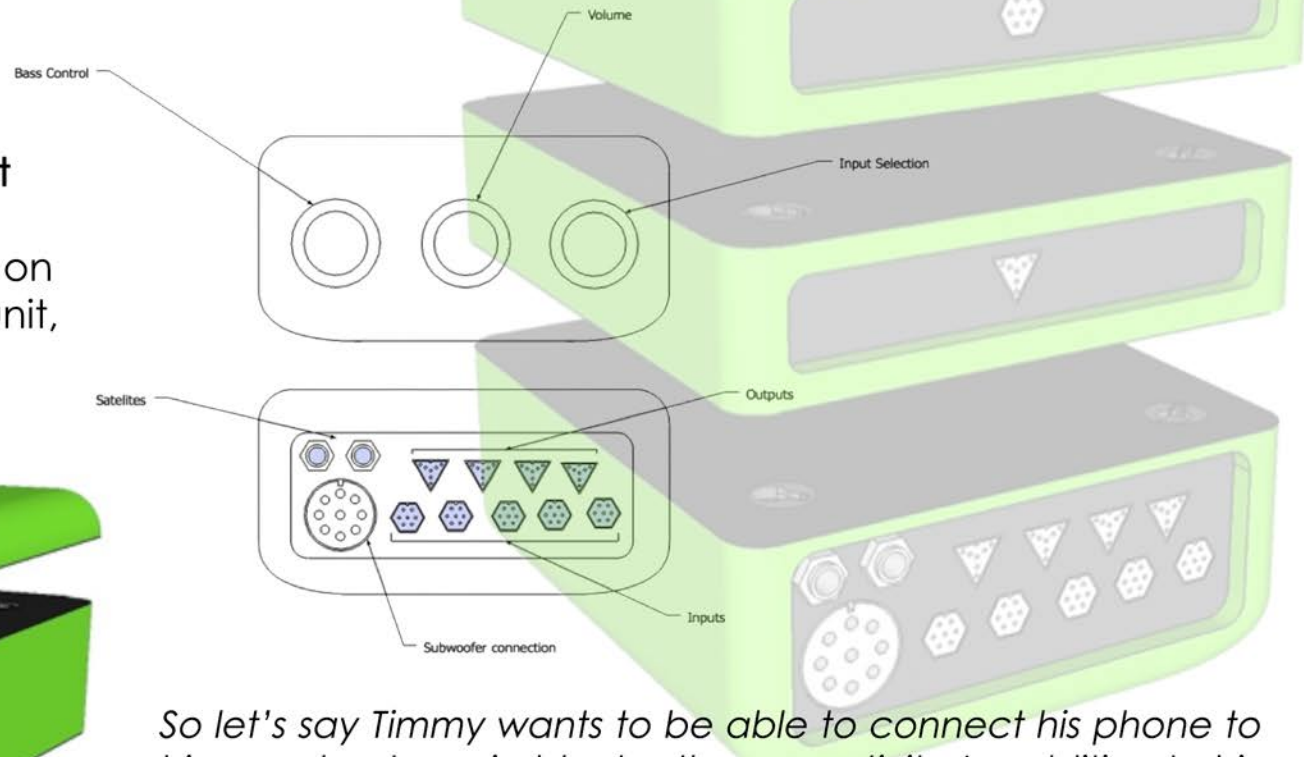

So let's say Timmy wants to be able to connect his phone to his sound system via bluetooth connectivity. In addition to his base purchase, he could buy the **bluetooth add-on module**.

I also thought up **output add-ons units**, which would allow Tim to include additional, wireless speakers into his system – thus enabling him to create a multi-room home entertainment system, 5.1 surround sound...or just a REALLY LOUD party setup.

And what if some crazy, new audio technology were to come out in five years? Would Tim's sound system become obsolete? Of course not! *My company could perpetually create add-ons that utilize the newest, cutting-edge technologies.*

*As I thought back to the countless hours that I'd spent  
on that business idea, I caught myself smiling.*

I really did enjoy that process –

**DESIGNING A PRODUCT THAT OTHERS COULD LOVE.**

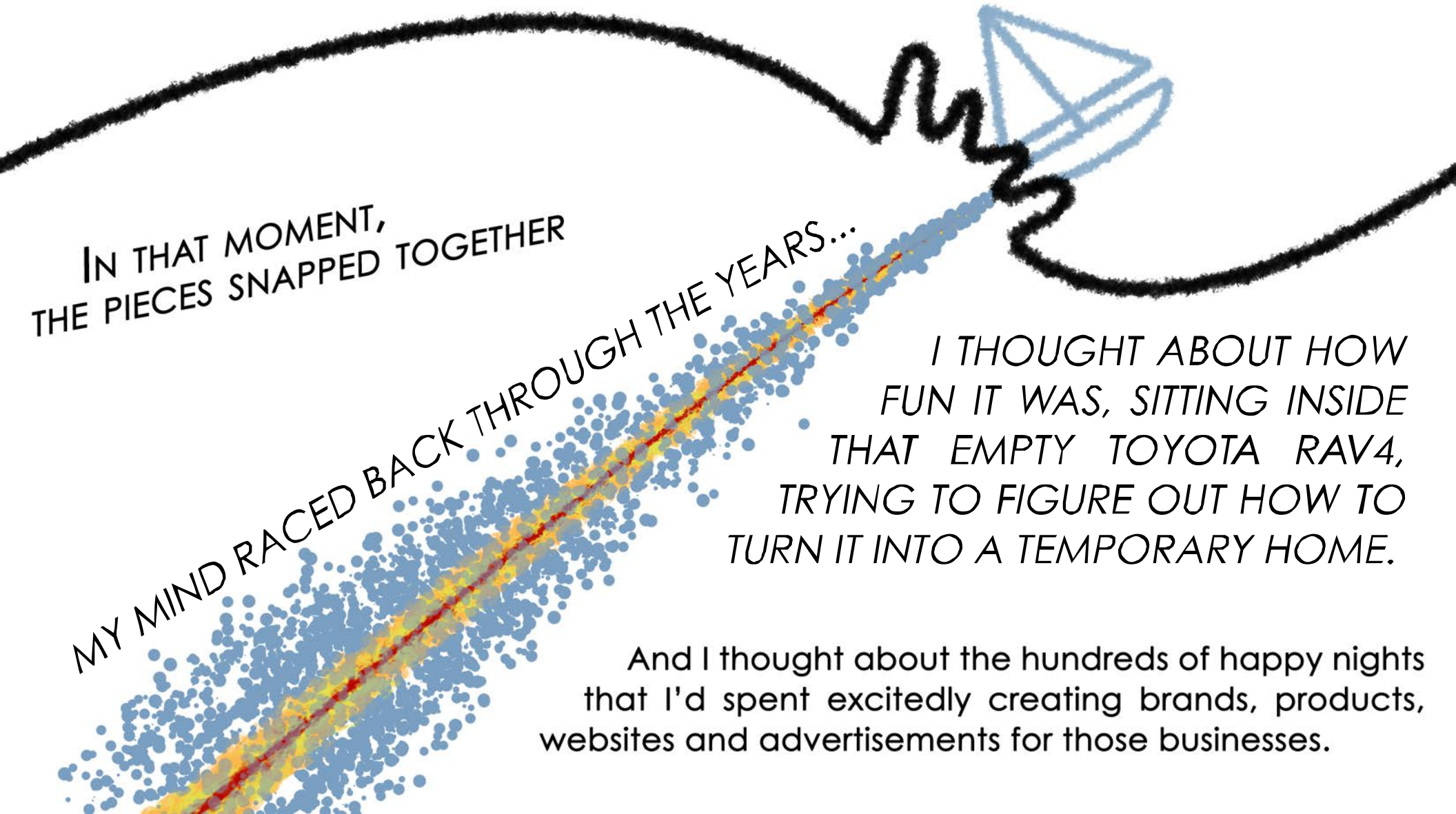

*IN THAT MOMENT,  
THE PIECES SNAPPED TOGETHER*

*MY MIND RACED BACK THROUGH THE YEARS...*

*I THOUGHT ABOUT HOW  
FUN IT WAS, SITTING INSIDE  
THAT EMPTY TOYOTA RAV4,  
TRYING TO FIGURE OUT HOW TO  
TURN IT INTO A TEMPORARY HOME.*

And I thought about the hundreds of happy nights  
that I'd spent excitedly creating brands, products,  
websites and advertisements for those businesses.

# MY THOUGHTS SHOT BACK TO MY CHILDHOOD

when I would sit for hours, alone in my room  
concocting designs and sketches of:

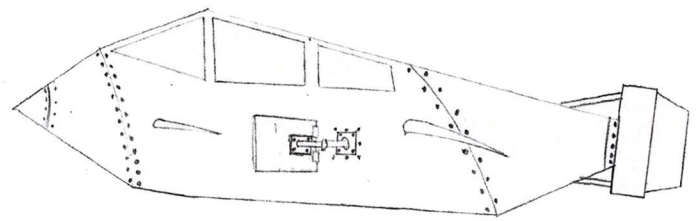

BUSINESSES I WAS GOING TO LAUNCH  
TOWNS & CITIES I WAS GOING TO DEVELOPE  
VEHICLES I WAS GOING TO EXPLORE IN  
HOMES THAT I WAS GOING TO BUILD

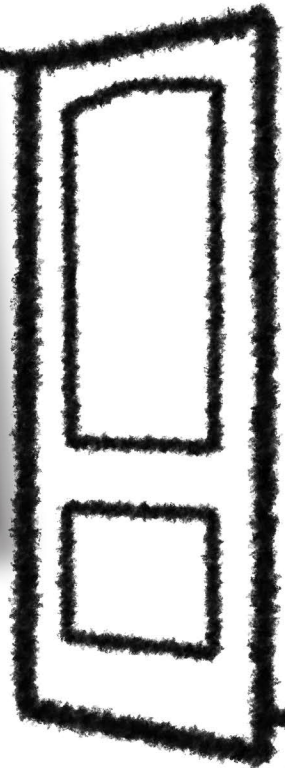
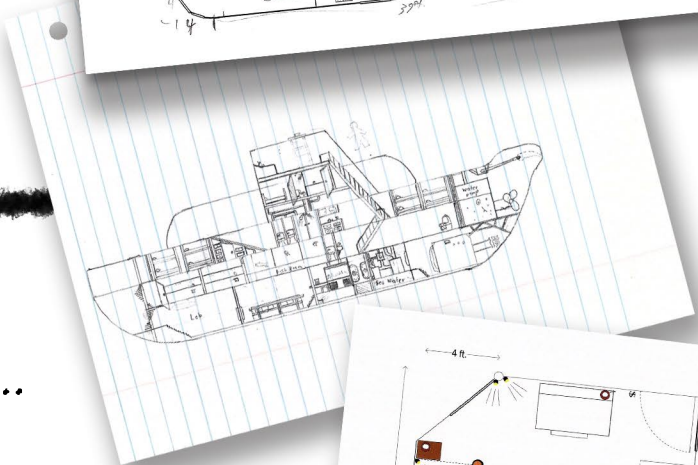
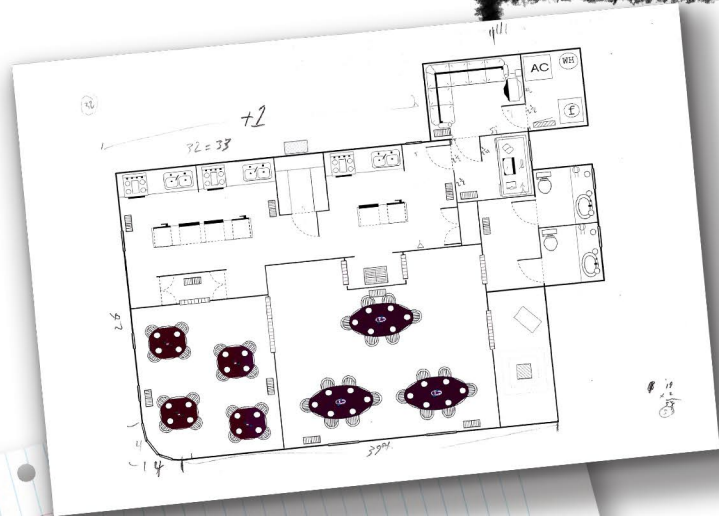

from the SUBMARINES  
and RESTAURANTS...

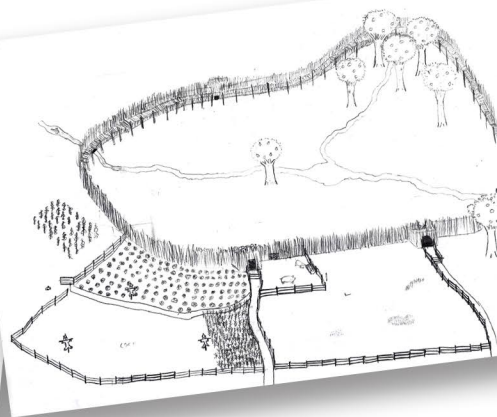
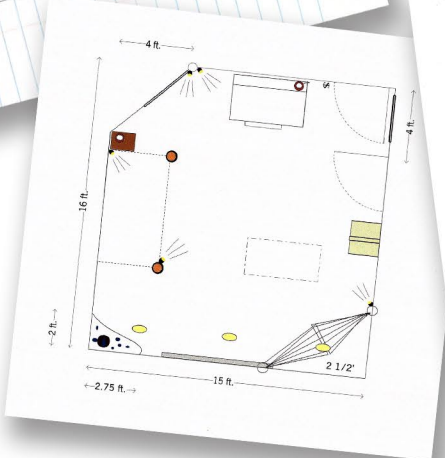
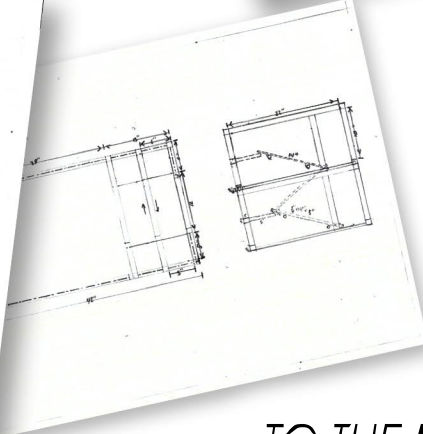
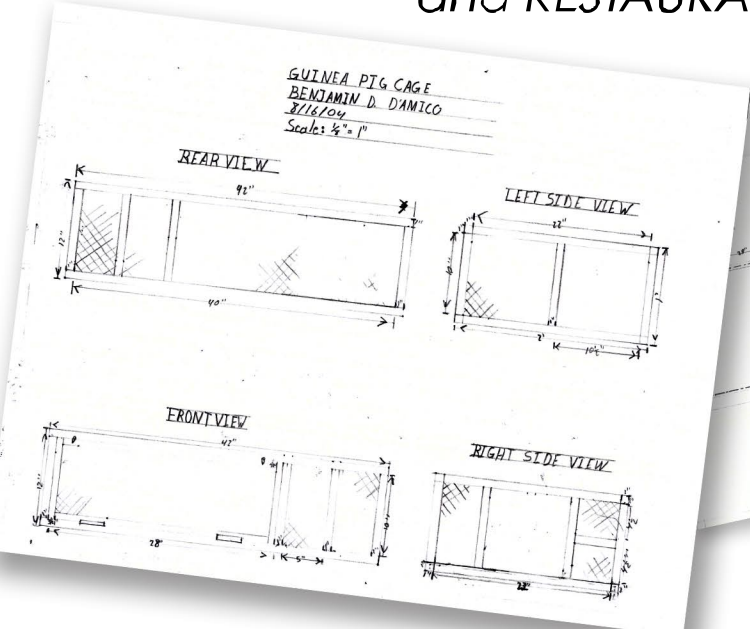

TO THE MODULAR, STACKING GUINEA PIG CAGES  
THAT I DESIGNED BACK IN THE 8<sup>TH</sup> GRADE.

AND I REMEMBERED THE COUNTLESS OTHER CREATIONS THAT I'D COME UP WITH OVER THE COURSE OF MY LIFE.



The DJing flight case that I designed and built from MDF and extruded aluminum, when I was going to take the world by storm as *DJ Benny D* (I was a freshman in college, of course).



The standing desk that I designed, in order to create a better work environment, while pushing towards my dream of becoming an entrepreneur.

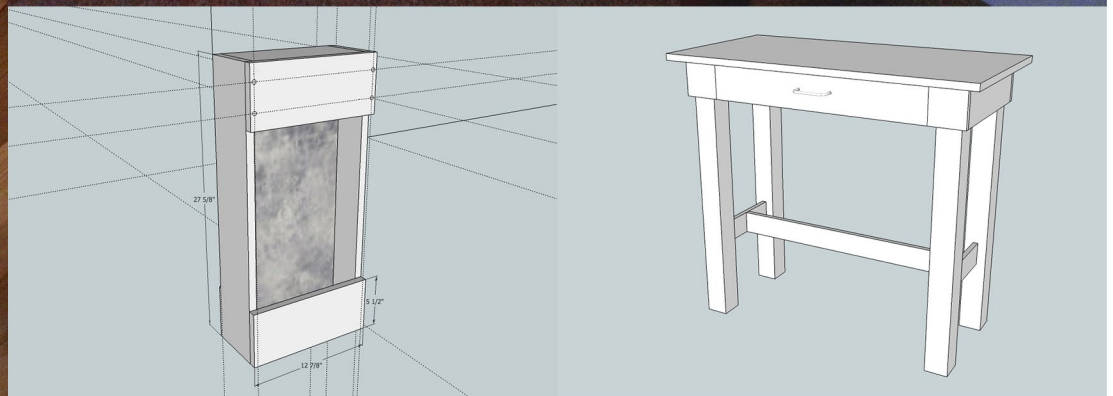

The trickling wall-mount fountain that I created – back while I was still copywriting – once I realized that having running water in my work space created a more productive, soothing writing atmosphere.

And then time suddenly stood still,  
*as I thought back to a warm, summer afternoon...*

A 7-year-old boy, standing alone in the yard,  
kicking a soccerball against the same spot on the  
side of the house for  
hours on end.

*A boy whose neighbors probably thought  
that he was overmedicated – because they  
didn't know what he was* **ACTUALLY**  
*doing:*

HE WAS THINKING, CREATING, SOLVING, DESIGNING,

**DAY DREAMING**

BECAUSE THAT'S WHAT HE

**LOVED TO DO**

THE WAVES WERE STILL BEATING THE HELL OUT OF THE BOAT.



Because in that moment of clarity on the deck of my boat,  
after years of wandering to and fro, attempting one “failed” path after the other,  
I finally understood what it is that I enjoy doing, *and that which I truly am:*

A THINKER, A CREATOR, A HOPEFUL IMAGINATOR...



# I AM A DESIGNER

And I'm searching for an opportunity to grow, to learn more about what it is that you do, and the field that I've unknowingly loved all of my life. While I may not have a degree in design, nor experience with a professional firm, I do have a passion for life and learning that will never die.

If there is something that I am excited to learn about, I will learn it – if I have a goal, then I'll reach it. And with an opportunity from you and your team, I know that I will be one step closer to my true desire for this lifetime: to shape this world into a more beautiful place, and to leave a lasting impact on the lives of all who come next.



724.953.2540



BEN@BENDAMICO.COM